

Varenummer: 03551050

Beskrivelse: Fluro hydraulik ledhoved FPR 50CE

Mål

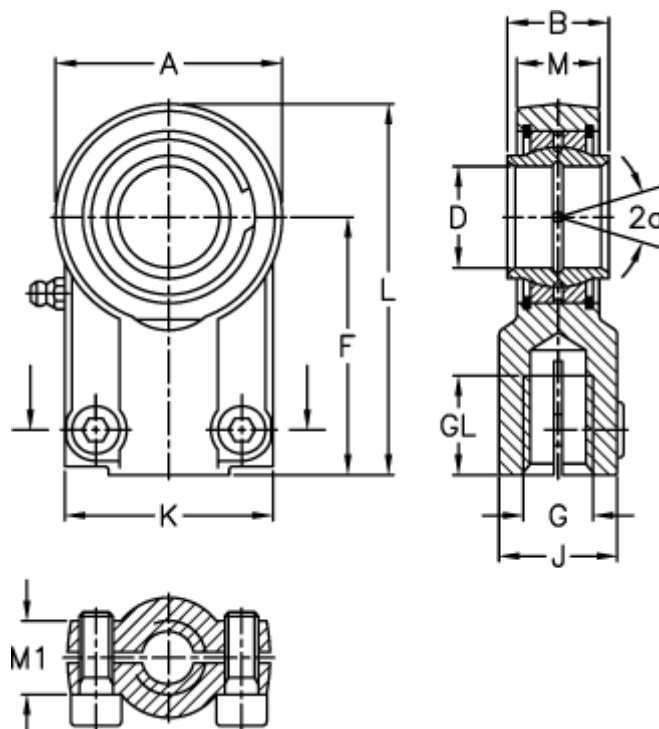

A	= 109	J	= 58
a (grader)	= 4	K	= 96
B	= 50	L	= 179.6
D	= 50	M	= 41
Dynamisk belastning C (kN)	= 156	M1	= 32
F	= 120	Moment (Nm)	= 86
g	= M42x2	Statisk belastning C0 (kN)	= 310
GL	= 57	Vægt	= 4400